

Drayton

Digistat

by Schneider Electric

3rd Generation

Programmable 2-Channel Room Thermostat Model: 22902

Technical Helpline Tel: 0333 6000 622

Website: www.draytoncontrols.co.uk

Email: customer.care@draytoncontrols.co.uk

User and Installation Guide 06490346001 Iss B

Installation guide

Before Installation

If you do not have the knowledge to install the thermostat safely then you must arrange for a competent electrician to install it for you. Wiring must conform to the current IEE regulations.

Prior to commencing the installation you must ensure the mains supply is switched off.

1. Remove the front cover by releasing the 2 screws at the bottom. Mounting holes and electrical connections are found underneath the hinged black cover (Fig 1).

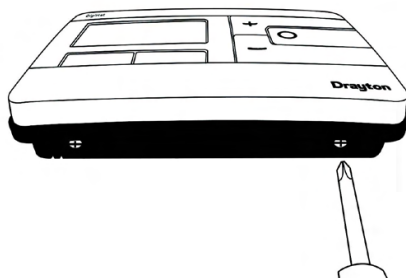

(Fig. 1)

2. Fix back plate directly onto the wall using suitable wall plugs and screws or mount over existing wall box (Fig 2).

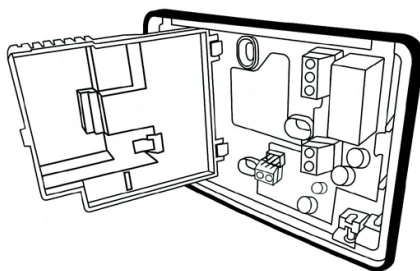

(Fig. 2)

3a. Complete the wiring according to the connections shown in Fig 3.

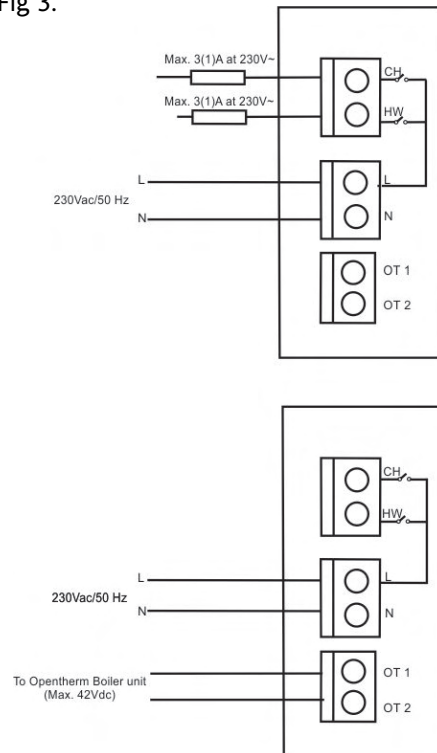

(Fig. 3)

3b. If your boiler supports OpenTherm please follow these instructions:

Remove the OpenTherm cables from the existing controller or thermostat. Connect the cables to the OpenTherm terminals OT1 and OT2 on the Digistat. Polarity is not important. Wire L and N from a separate supply with a 3A fuse. Note that when connected to an OpenTherm boiler, Installer Options 06 Valve Protection and 08 Application Type are not available. The following options will appear in the Installer Options list:

10 Upper CH water set point	30-80°C	Default 70°C
11 Lower CH water set point	10-25°C	Default 10°C
12 Set HW temp	45-65°C	Default 60°C

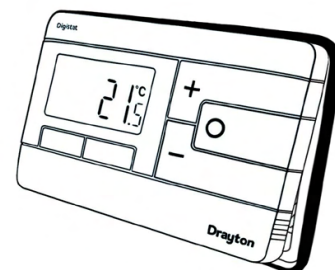

4. Close the black hinged terminal cover and replace the front cover by locating the two latches at the top then fasten the 2 screws at the bottom (Fig 4).



(Fig. 4)

5. The Digistat is now installed and will automatically start to control the room temperature.

INSTALLER OPTIONS

To make changes to the default Installer Options shown below, enter the Installer Options menu by pressing the settings button  for 3 seconds. This allows access to the User Menu 01, the Advanced User Settings Menu 02, the Installer Settings 03, and Service Interval Settings 04. Use the + and - buttons to scroll to Installer Options and press O to select. You can exit the menu by pressing  until you have returned to the home screen. In the Installer Options menu (Fig 8), scroll through the options using the + and - buttons and press O to select. Scroll through the different settings using the + and - buttons and press O to select and save. (Fig 9 shows Option 02 OFF).



(Fig. 8)



(Fig. 9)

(Option 01) Partial Sight Assistant

When enabled, audible tones indicate when the setpoint is more than, less than or equal to the current room temperature when a user manually adjusts the setpoint using the + button: Setpoint > room temperature - single high tone per 0.5°C increase

Setpoint = room temperature - double tone

Setpoint < room temperature - single low tone per 0.5°C decrease

(Option 02) Frost Protection

The Digistat will switch on the heating if the temperature falls to 5°C and maintains a temperature of 7°C even when in OFF mode.

(Option 03) Minimum Setpoint Limit

Change minimum setpoint temperature. After any changes to setpoint limits, all setpoints in AUTO, MANUAL, BOOST and HOLIDAY modes will be modified to conform accordingly.

(Option 04) Maximum Setpoint Limit

Change maximum setpoint temperature. After any changes to setpoint limits, all setpoints in AUTO, MANUAL, BOOST and HOLIDAY modes will be modified to conform accordingly.

(Option 05) Optimum Start

When enabled, this uses current ambient temperature, the next scheduled setpoint and heat gain data captured by the device to adjust the thermostat setpoint early, so the ambient temperature is at the required level when the next event starts.

Delayed Start

When enabled, this uses current ambient temperature, current event setpoint and heating characteristics of the environment to delay implementation of the setpoint if the ambient temperature is already close to it, therefore saving energy.

(Option 06) Valve Protection Time

In some hydronic heating systems it may be required to protect the valve by operating it for a given time. When enabled, this maintenance feature ensures that each relay output is operated for at least one (1) minute each week.

(Option 07) Sensor Fault Function

In the event of a sensor fault, central heating output is reduced to 30% by turning heating ON for 3 minutes, then OFF for 7 minutes.

(Option 08) Application Type

Select the central heating system energy type.

(Option 09) System Capability

Select the flow capability of the heating system.

(Option 13) Installer Settings Lock

When enabled, you can lock the installer settings until a 3 digit code is entered.

(Option 20) Reset (Service Interval settings are NOT reset)

Reset the Digistat to its original factory settings.

Service Interval Options continued on reverse.

	What is it	Screen Abbreviations	Select between				Default
Installer Options	01 Partial Sight Assistant	bEEP	OFF	ON			ON
	02 Frost Protection	FrSt	ON	OFF			ON
	03 Low Set Point C	LoSP	5	High Limit			5
	04 High Set Point C	HiSP	Low Limit	30			30
	05 Optimum Start	OPSt	OFF	Delayed Start	Optimum Start		OFF
	06 Valve Protection Time	vPrt	OFF	5	4	3 2 1	OFF
	07 (Mins) Sensor Fault Function	SEnS	OFF	ON			OFF
	08 Application Type	APPL	Gas	Electric	Oil	Heat Pump	Gas
	09 System Capability	SySt	Fast Flow	Normal/Slow Flow			Fast Flow
	13 Installer Settings	LOC	OFF	ON			OFF
20 Lock Reset	rSEt	NO	YES			NO	
Service Interval Options	01 Si Status	StAt	OFF	ON			OFF
	02 Si Type	tYPE	Reduced Comfort	Heating OFF	No Effect		Reduced Comfort
	03 Si Due Date	dUE	YY/MM/DD				
	04 Si Warning	WArn	0	99			30
	05 Si Due Alarm	ALAr	OFF	ON			OFF
	06 Si Boost	bSt	OFF	ON			OFF
	07 Si Password Reset	COdE	EXIT	Select 4-digit PIN			0000

INSTALLER OPTIONS - *continued*

(Si Option 01) Si Status

Enable or disable Service Interval Mode.

(Si Option 02) Si Type

Select effect imposed on the heating when service is due.

(Si Option 03) Service Due Date

Set date when next service is due.

(Si Option 04) Warning

Select no. of days before service due date.

(Si Option 05) Service Due Alarm

Enable or disable the audible service due alarm.

(Si Option 06) Si Boost

Enable or disable the Service Boost feature (5 boosts).

(Si Option 07) Password Reset

Change the 4 digit PIN. If you forget your Si password, please call the Technical Helpline.

Technical Data

Power supply	230VAC +/-10%, 50Hz
Switch type & rating	3(1)A at 230V / 50Hz
Min. recommended current	SPDT (voltage free contacts) 10mA@24VAC (inductive)
Ambient temperature	Operating: 0°C to +40°C Storage: -20°C to 65°C
Ambient humidity (non condensing)	20% to 80%, 90% non-condensing
Temperature range	5°C to 30°C
Rated impulse voltage	4KV
Ball pressure test	75°C
Disconnection means	1B
Automatic action	100,000 cycles
Operating Frequency	2402-2480 MHz
Max RF Power transmitted	+10dBm
Pollution situation	Degree 2
Protection level	IP30
Wiring	Designed for fixed wiring only, to comply with IEE wiring regulations
Energy Class	V = 3% using OpenTherm connection
Relevant EC Directives:	2014/53/EU (RED) 2011/65/EU (RoHS) 2012/19/EU (WEEE)
Standards:	EN 60730-1 EN 60730-2-7 EN 60730-2-9 ESTI EN 300 328 ESTI EN 301 489 EN IEC 63000

User Guide

The Drayton Digistat thermostat is a universal thermostat with 24 hour, 5-2day or 7day program types and up to 8 time/temperature events per day and can also be used as a simple room thermostat.

Clock Setting

- Press and hold the cog button until User 01 appears,
- Press the plus button to Advanced 02, then press O to enter,
- Press O to enter Time settings,
- Using the + and - you can adjust the time, then press O to save,
- Press the cog button twice to bring you back to the home screen.

General Operation

Programmable thermostats do not have "On" and "Off" times like traditional timers. They offer temperature control both day and night and you simply select which temperatures you require at each point in the day.

With the unit in "Auto Mode" (the calendar icon is visible at the bottom of the screen) the temperature can be changed for a short time by using the + and - buttons. Changing the temperature in this way will keep the Digistat set to your new temperature until the next pre-programmed event (at which time it will revert to programmed temperature). The temperature you are setting will flash on the screen. Once temperature is set, the unit will revert to showing the room temperature again. The indicator will show on the screen if the unit is calling for heat.

Programming the Digistat

Your Digistat comes with the following settings pre-programmed for your convenience and is suitable for those working out of the house during a typical 9-5 pattern. When the 5-2day program type is selected the pre-set temperatures will be different Mon-Fri and Sat-Sun, as per the tables below:

Pre-set Program 1 (24h, 5-2day weekdays, or 7day):

Event	1	2	3	4	(5)*	(6)	(7)	(8)
Time	06:30	08:30	16:30	22:30				
Temperature	20°C	16°C	21°C	OFF				

Pre-set Program 1 (5-2day weekend):

Event	1	2	3	4	(5)*	(6)	(7)	(8)
Time	07:00	09:00	16:00	23:00				
Temperature	20°C	18°C	21°C	OFF				

**To add these additional time periods manually (max. 8 per day) please refer to the steps to the right.*

The Bluetooth® word mark and logos are registered trademarks owned by Bluetooth SIG, Inc. and any use of such marks by Schneider Electric is under license. Other trademarks and trade names are those of their respective owners.

Hereby, Schneider Electric Controls UK Ltd, declares that Digistat 22902 is in compliance with Directive 2014/53/EU. The declaration of conformity may be consulted at www.draytoncontrols.co.uk

What is a programmable room thermostat?

...an explanation for householders



A programmable room thermostat is both a programmer and a room thermostat. A programmer allows you to set 'On' and 'Off' time periods to suit your own lifestyle. A room thermostat works by sensing the air temperature, switching on the heating when the air temperature falls below the thermostat setting, and switching it off once this set temperature has been reached.

So, a programmable room thermostat lets you choose what times you want the heating to be on, and what temperature it should reach while it is on. It will allow you to select different temperatures in your home at different times of the day (and days of the week) to meet your particular needs.

Turning a programmable room thermostat to a higher setting will not make the room heat up any faster. How quickly the room heats up depends on the design of the heating system, for example, the size of boiler and radiators.

Neither does the setting affect how quickly the room cools down. Turning a programmable room thermostat to a lower setting will result in the room being controlled at a lower temperature, and saves energy.

The way to set and use your programmable room thermostat is to find the lowest temperature settings that you are comfortable

with at the different times you have chosen, and then leave it alone to do its job. The best way to do this is to set low temperatures first, say 18C, and then turn them up by one degree each day until you are comfortable with the temperatures. You won't have to adjust the thermostat further. Any adjustments above these settings will waste energy and cost you more money.

If your heating system is a boiler with radiators, there will usually be only one programmable room thermostat to control the whole house. But you can have different temperatures in individual rooms by installing thermostatic radiator valves (TRVs) on individual radiators. If you don't have TRVs, you should choose a temperature that is reasonable for the whole house. If you do have TRVs, you can choose a slightly higher setting to make sure that even the coldest room is comfortable, then prevent any overheating in other rooms by adjusting the TRVs.

The time on the programmer must be correct. Some types have to be adjusted in spring and autumn at the changes between Greenwich Mean Time and British Summer Time.

You may be able to temporarily adjust the heating programme, for example, 'Override', 'Advance' or 'Boost'. These are explained in the manufacturer's instructions.

Programmable room thermostats need a free flow of air to sense the temperature, so they must not be covered by curtains or blocked by furniture. Nearby electric fires, televisions, wall or table lamps may prevent the thermostat from working properly.

Setting up Times/Temperatures on the Digistat

1. With the product operating as normal in Auto Mode, press once. Use + and - to select the day or set of days you want to adjust the times and temperatures for. Press O to confirm.



2. The time on the display will now be flashing as shown, use + and - to adjust the first period start time. Press O to confirm.

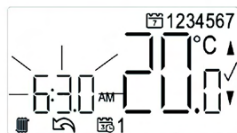

3. Once the time has been set the temperature on the display will now be flashing, use + and - to adjust the temperature for the first time period. Press O to confirm.

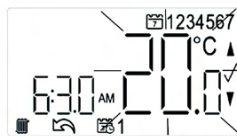

4. Move to the next time and temperature periods and adjust as needed, confirming the changes by pressing O. The new schedule will be saved pressing O when the word SAVE is flashing.



5. In Pre-set Program 1 you will have 4 time periods available, to add more (max. 8 per day) press + when you see the SAVE option on-screen and time period 5 at the bottom of the screen, to scroll to the Add option. Press O to add time period then adjust time and temperature as required.



6. To exit press to go back until you return to the home screen.



Heating or Hot Water

1. Press the cog button so the tap or radiator symbol in the bottom left-hand corner starts to flash.
2. Press the + button to change between the options, then press O to select your option.

Automatic to Manual

1. Press and hold the Cog button until you see USER 01,
2. Press the O button to select and you will see Mode,
3. Press O to enter and you will see either Auto, man or off.
4. Use the + and - button to choose between these options.
5. Press the O button to select your option then press the Cog button twice to take you to the home page.

Where to find User Guide

Please use the QR code to the right or go to our website www.draytoncontrols.co.uk to download our full online user guide which also features Bluetooth pairing, and how to use the smartphone app.



Schneider
Electric

401 Southway Drive
Plymouth
PL6 6QT
United Kingdom

Schneider Electric Industries
SAS 35 rue Joseph Monier
F-92500 Reuil-Malmaison
France