

Continued from overleaf

Combi-Stat boiler compatibilty information

Make	Model	
Alpha	240	2 wire
	Ocean 80	3 wire
Ariston	Genus 27	2 wire
	Euro Combi 27	2 wire
Biasi	Prisma	2 wire
	Riva	3 wire
Chaffoteaux	Britony Combi 80	3 wire
	Celtic FF	3 wire
Ferrolli	Domina 80	2 wire
	Modena 80	2 wire
Halstead	Finest	2 wire
	Finest Gold	2 wire
Radiant	RSF 24	2 wire
Ravenheat	RSF 820/20	2 wire
	CSI 85 Condensing	2 wire
Saunier	Duval 623 Combi	2 wire
Myson	Midas BF	2 wire
Elm	Le Blanc	2 wire

THERMOSTAT INTERCHANGE GUIDE

Make	Model	Earth	Neutral	Live	Common	Demand	Satisfied
British Gas	RS1		N		L	3	
British Gas	RS2 (for 2 wire connection with loads of 0.1 to 0.6 A)				L	2	
British Gas	RS2 (for 2 wire connection with loads 0.6 to 6A)				L	3	
British Gas	RS2 (for 3 wire connection with loads under 2A)		N		L	3	
British Gas	RS4		N	L	1	3	2
Drayton	RTS7 and RTS8 (for 2 wire connection with loads of 0.1 to 0.6 A)				L	2	
Drayton	RTS7 and RTS8 (for 2 wire connection with loads 0.6 to 6A)				L	3	
Drayton	RTS7 and RTS8 (for 3 wire connection with loads under 2A)		N		L	3	
Drayton	RTS 1		N		L	3	
Drayton	RTS 2		N		L	3	
Drayton	RTS 4		N	L	1	3	2
ACL Lifestyle	TS 142	E	4		1	2	
ACL Lifestyle	TA 350	5			1	3	2
Drayton (old version)	RT		4		1	2	3
Drayton (old version)	RTE		4		1	2	3
Danfoss Randall	RMT230		4		1	2	3
Danfoss Randall	RET230		N	L	3	4	
Danfoss Randall	RT1				1	3	2
Danfoss Randall	RD3		4		1	2	
Danfoss Randall	RD3A		4		1	2	
Danfoss Randall	RTC	E	N		3	1	2
Danfoss Randall	RTM	E	N		3	1	2
Danfoss Randall	RSR	E	N		3	1	2
Danfoss Randall	R504		N		3	1	2
Honeywell	T4360B				1	3	
Honeywell	T6060B		2		1	3	4
Honeywell	T6061B		2		1	3	4
Honeywell	T6063B		2		1	3	4
Honeywell	T6360B		2		1	3	4
Horstmann	HRT1	E	4		1	2	
Horstmann	Centuarstat				1	2	3
Landis & Gyr	RAD 1	E			1	2	3
Landis & Gyr	RAD 1N				1	2	3
Landis & Gyr	RAD 1EM				1	2	3
Potterton	PRT 1		N		L	H	
Potterton	PRT 2		N		TL	H	
Potterton	PRT 100 ST		N		TL	H	
Potterton	PRT 100 DT		N		TL	H	C
Sunvic	TLX 2222	E	4		3	1	
Sunvic	TLX 2259	E	N		L/3	1	
Sunvic	TLX 2356	E	N		3	1	2
Sunvic	TLX 2654	E	4		3	1	
Sunvic	TLX 2852	E	4		3	1	2
Sopac	TA 350	E			1	3	2
Sopac	TA 351	E	4		1	3	2
Switchmaster	SRT 2	5			1	3	2
Tower	SS	E	4		1	2	

NOTE: British Gas RS2 & Drayton RTS7 details are for guide use only. ALWAYS follow above instructions.

TECHNICAL DATA

Electrical supply 24V-230V AC/DC
Double insulated no earth required

Temperature range 10°C to 30°C

Switch type SPST 6(2)A
See Figs 5 to 7 for supply voltage and maximum loads which are dependant on wiring configuration used

Temperature sensor Bi metallic

RELEVANT EC DIRECTIVES:

2014/35/EU Low Voltage Directive
2014/30/EU Electromagnetic Compatibility
2011/65/EU RoHS Directive

APPLIED STANDARDS:

EN60730-1, EN60730-2-9

Energy Class I = 1% (According to EU 811/2013, 812/2013, 813/2013, 814/2013)

Drayton

401 Southway Drive
Plymouth
PL6 6QT
United Kingdom
Technical Helpline Tel: 0333 7000 622
Website: www.draytoncontrols.co.uk
Email: customer.care@draytoncontrols.co.uk

6490018-1 Iss E
0503

Drayton Controls reserve the right to make changes without notice and cannot accept liability for errors.

Drayton

by Schneider Electric

Combi-Stat RTS8 Room Thermostat Installation instructions

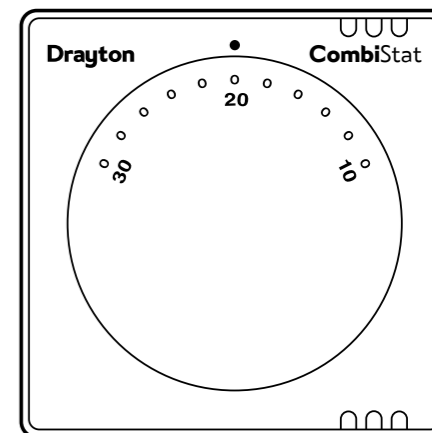

RTS8 Combi-Stat Thermostat

The RTS8 is a 24V-230V AC/DC mechanical thermostat that can be used for either 2 or 3 wire applications, making it suitable for replacement of older 2 wire thermostats with no Neutral, or 3 wire thermostat replacement where a Neutral connection has been used. (Optimum performance is attained with 3 wire connection.)

IMPORTANT NOTES

The installation instructions must be followed for this thermostat to operate correctly. Failure to do so may result in inadequate room temperature control and also the unit may be damaged if wired incorrectly.

Particular attention should be paid to the sections on wiring and set up.

All electrical work should be carried out by a competent person to conform to all relevant standards and regulations.

Isolate/disconnect the power supply to the appliance and/or system before commencing any electrical work.

A switch having a contact separation of at least 3mm on both Live and Neutral poles must be incorporated in the fixed wiring of the system to provide full isolation of the mains supply.

Ensure that the system fuse is the correct rating. For Gas fired radiator heating systems this is 3A.

INSTALLATION INSTRUCTIONS

Location

Care should be taken to mount the thermostat in a position, which is not subject to direct sunlight or draughts. Preferably it should be mounted on an inside wall about 1.5m (5ft) above the floor in a position where it can respond to room temperature but away from the direct influence of radiators or other appliances giving off heat.

Fixing

Standard cable entry can be from the rear or top, if bottom entry or extra space for cabling is required use the optional Pattress box.

1. Pull temperature setting knob forward to remove.

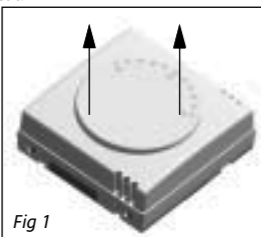

Fig 1

2. Undo the captive restraining screw

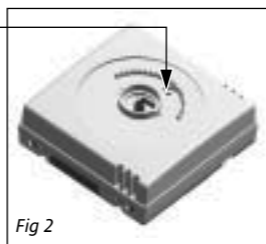

Fig 2

3. Hinge from bottom and pull top forward. Lower outer cover to remove



Fig 3

4. Fix directly to a flat wall or onto a flush mounting conduit box or optional Pattress box using suitable screws

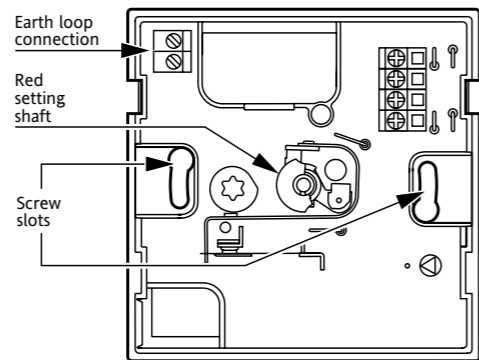

Fig 4

Wiring

The RTS8 is double insulated and does not require an earth, if there are existing earth wires that need to be connected, use the Earth loop connection (Fig 4).

Terminate the wiring as shown in diagrams (Figs 5 to 7), ensure that the correct diagram is followed to match the current load (Amps) and cabling of the heating system. If unsure of current load, follow **Set up procedure** to determine it.

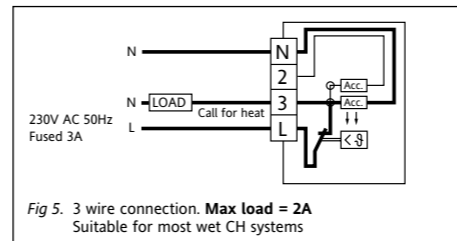

Fig 5. 3 wire connection. **Max load = 2A**
Suitable for most wet CH systems

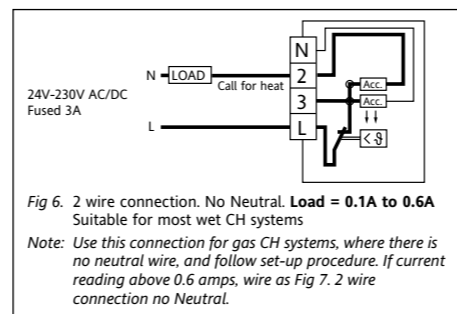

Fig 6. 2 wire connection. No Neutral. **Load = 0.1A to 0.6A**
Suitable for most wet CH systems

Note: Use this connection for gas CH systems, where there is no neutral wire, and follow set-up procedure. If current reading above 0.6 amps, wire as Fig 7. 2 wire connection no Neutral.

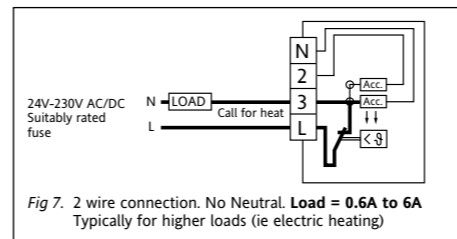

Fig 7. 2 wire connection. No Neutral. **Load = 0.6A to 6A**
Typically for higher loads (ie electric heating)

Set up to be followed when wiring to Fig 6 only

The thermostat utilises a series resistor as a heat anticipator when wired in accordance with Fig 6 diagram.

To avoid inaccurate room temperature control it is **VERY IMPORTANT** that the following set up procedure is followed.

An electrical multimeter will be required for the following procedure.

- Isolate electrical supply
- Mount base unit to wall
- Connect wires to L and 2
- Turn red setting shaft until switch contact opens (see Fig 4)
- Set meter to 1 amp, current range
- Carry out electrical safety checks on the system/appliance and turn system ON
- Put meter probes across L and 2
- Read current. *Expected reading for Gas CH systems = 0.1A to 0.6A*
- If reading is **BELOW 0.6A** wire as Fig 6 (isolate electric supply before rewiring)
- If reading is **ABOVE 0.6A** wire as Fig 7 (isolate electric supply before rewiring)
- Reset the red setting shaft so that the small slot is vertically downwards
- Reassemble thermostat

Range limiting

The setting range may be limited or a particular setting locked through the use of the mechanism to be found under the control knob.

To set the range limits:

1. Set thermostat to the desired temperature
2. Remove the setting knob by carefully pulling it forward
3. Lift and rotate the two limiting arms to reposition them in the required notches
4. Replace the knob in its previous position

Combi-Stat boiler compatibility information

Make	Model	Wiring
Worcester	Series	2/3 wire*
	CDi Series	3 wire
	Si Series	2/3 wire*
Vaillant	EcoMax	2/3 wire*
	TurboMax	2/3 wire*
Ideal	Isar	2 wire
	Response	2 wire
	Mini	2 wire
Glow-Worm	Energysaver	2/3 wire*
	Compact E	2/3 wire*
Baxi	80 Eco	3 wire recommended by Baxi across range
	Combi 80E	3 wire recommended by Baxi across range
	105E	3 wire recommended by Baxi across range
	Maxflow	3 wire recommended by Baxi across range
Potterton	Bahama	3 wire recommended by Pott's across range
	Puma	3 wire recommended by Pott's across range
	Combi	3 wire recommended by Pott's across range

* Where 2/3 wire is indicated use 3 wire connection for optimum performance. This information is for guidance only as the boiler manufacturer may change the mode of operation at any time without warning. For further information please refer to the boiler manufacturers handbook.

Continued overleaf