

# Drayton Digistat +2

## Programmable Room Thermostat

24 Hour

Models:  
22084 / 22088

Power Supply:  
Battery / Mains



Technical Helpline Tel: 0333 7000 622  
Website: www.draytoncontrols.co.uk  
Email: customer.care@draytoncontrols.co.uk

Installation / User Guide 06490045001 Iss F

## Installation Guide

### Warning

If you do not have the knowledge to install the *Digistat+2* safely, arrange for a competent electrician to install it for you. Wiring should conform to the current IEE wiring regulations. Isolate mains supply before removing an existing room thermostat and fitting *Digistat+2*. *Digistat+2* programmable room thermostats are double insulated therefore Neutral and Earth connections are not required. Unused existing cables should be safely insulated.

### Location

Care should be taken to mount the *Digistat+2* on a wall, in a position which is not subject to direct sunlight or draughts. Preferably it should be mounted on an inside wall about 1.5M (5ft) above the floor in a position where it can respond to room temperature but away from the direct influence of radiators or other appliances giving off heat.

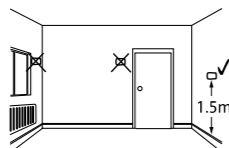

### Installation

1. Remove the front cover using a flat screwdriver and separate from back plate (Fig 1).
2. Fix the back plate directly onto the wall using suitable wall plugs and screws or mount over existing wall box (Fig 2).
3. Complete the wiring according to the connection suggestions shown in (Fig 3). For Basic boiler, Combi boiler and Basic boiler with zone valve applications *Digistat+2* with battery or mains supply are suitable.  
**For Electric Heat application use *Digistat+2* with mains supply only.**
4. Replace the front cover by locating in position and pushing fully onto the back cover (Fig 4).
5. Remove the battery cover using a coin (Fig 5). Battery model only.
6. Install the 2 AA batteries provided (Fig 6). Battery model only.
7. Replace battery cover (Fig 7). Battery model only.
8. The *Digistat+2* is now installed and will automatically start to control the room temperature according to the pre-set program 1 as shown in the User Guide. The display shows the correct time and date which is automatically set together with the actual room temperature.

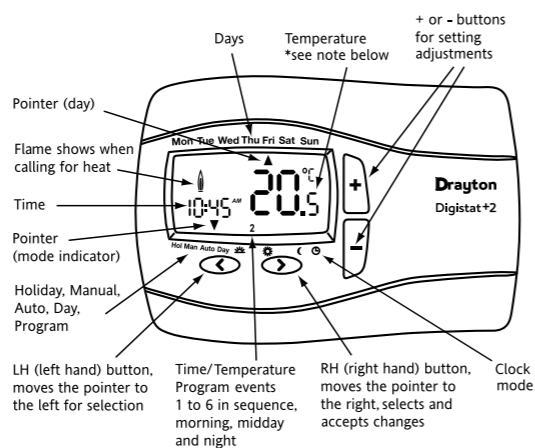
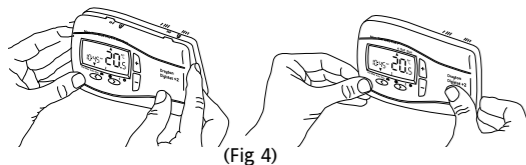

LH (left hand) button, moves the pointer to the left for selection  
Time/Temperature Program events 1 to 6 in sequence, morning, midday and night  
RH (right hand) button, moves the pointer to the right, selects and accepts changes  
Clock mode

\* Temperature displayed is actual room temperature unless adjusting the + or - button when it displays the set temperature. Once adjustment is complete and after 5 seconds this will return to actual room temperature

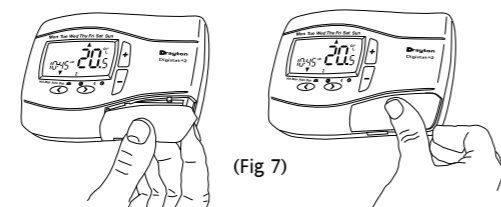
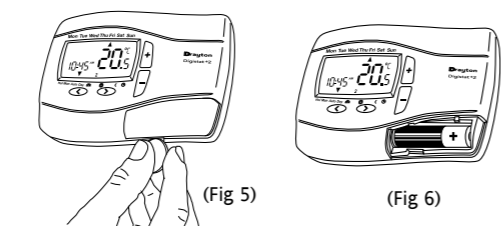
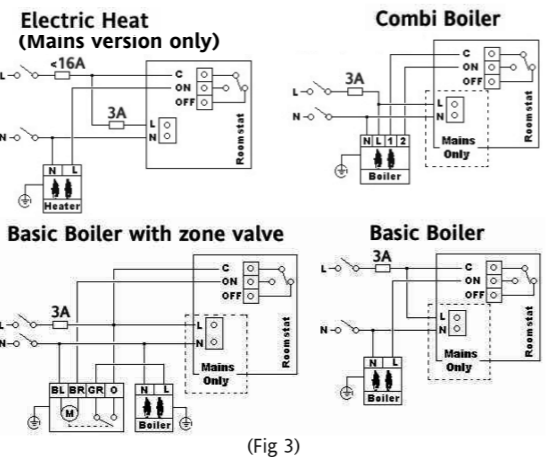
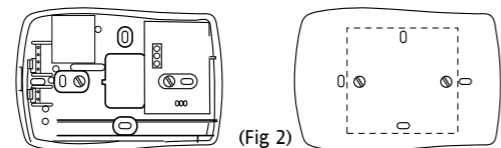
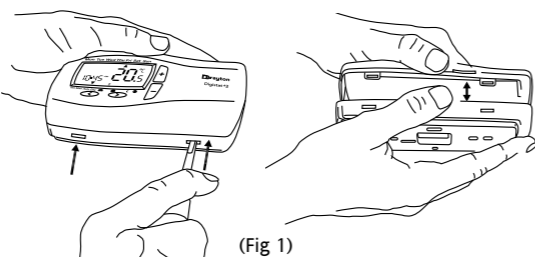

# Drayton Digistat +2

## Programmable Room Thermostat

24 Hour

Models:  
22084 / 22088

Power Supply:  
Battery / Mains



Technical Helpline Tel: 0333 7000 622  
Website: www.draytoncontrols.co.uk  
Email: customer.care@draytoncontrols.co.uk

Installation / User Guide 06490045001 Iss F

## User Guide

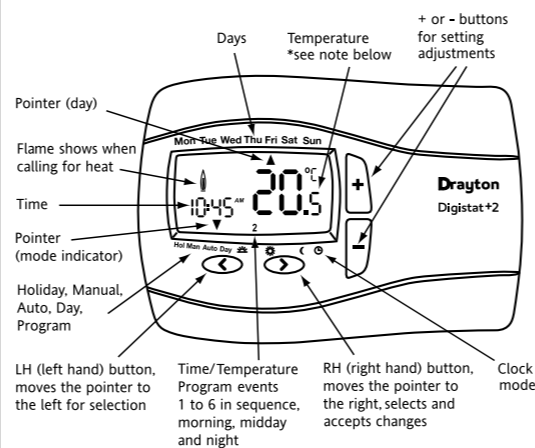

LH (left hand) button, moves the pointer to the left for selection  
Time/Temperature Program events 1 to 6 in sequence, morning, midday and night  
RH (right hand) button, moves the pointer to the right, selects and accepts changes  
Clock mode

\* Temperature displayed is actual room temperature unless adjusting the + or - button when it displays the set temperature. Once adjustment is complete and after 5 seconds this will return to actual room temperature.

### Your *Digistat+2* programmable room thermostat. 24 Hour

*Digistat+2* programmable room thermostat allows you to set time and temperature periods (up to 6 per day) to suit your own lifestyle. Once fully installed and powered the *Digistat+2* will automatically set the correct time and in auto mode will control your heating system according to pre-set program 1 (9 till 5). The temperature is controlled by sensing air temperature, switching on the heating when the air temperature falls below the thermostat setting and switching it off once this set temperature has been reached.

**How to change the temperature for a short time (Override).**  
When in Auto mode you can override the existing temperature setting by pressing + or -. During adjustment the temperature will flash then stop. The *Digistat+2* will now control at this temperature until the next programmed time/temperature event is reached, when the *Digistat+2* will revert back to Auto mode. Whilst in temperature override the pointer indicates both Man and Auto. To exit override press > to return to Auto. (Fig 1) shows *Digistat+2* in override.

**How to set a constant room temperature (Manual mode).**  
Manual mode will allow you to set a temperature, over-riding all programs, until you exit manual mode. In this mode all pre-set time temperature events will be disabled. To enter manual mode press < until the pointer indicates MAN (Fig 2). The screen will only show the temperature, which can be adjusted by pressing + or -. Once you have set the temperature it will flash for 5 seconds and then stop. The *Digistat+2* will now control at this temperature until you adjust using + or - or exit by pressing > to enter Auto mode.

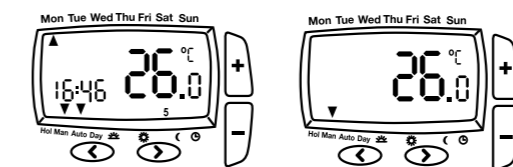

(Fig 1)

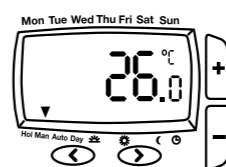

(Fig 2)

### How to set my room temperature for my holiday period. (Holiday Mode)

When going on holiday you can lower the temperature of your home for the duration of your holiday, but set *Digistat+2* to return to your normal programming ready for your return. Holiday mode works by counting down the days or hour until your return. Time periods of between 1 to 24hr then 1 day to 199 days can be set.

### Example

*I am ready to leave for my 2 week (14 day) holiday and would like the house temperature held at a constant 10.0 °C during this time and on my return the house temperature will be already running at my normal pre-set temperature.*

To enter Holiday mode press the < button until the pointer is indicating HOL (Fig 3). The temperature will flash and by pressing the + or - buttons you can change to the temperature required (in this example to 10.0 °C) (Fig 3a). Then press < again to set the time period (in this example 14 days) using the + or - buttons. (it would be advisable in this example to set the time period 1 day less (13 days) to ensure the house temperature is back to normal on your return). (Fig 3b) Once you have set your time period the time will flash for 10 seconds and then start the holiday period. To exit the Holiday mode press either < or > to return to auto mode.

When changing time the display will scroll through Hr (Hours) 1-24 then d (Days) 1-99. The display will show holiday time period and set temperature.

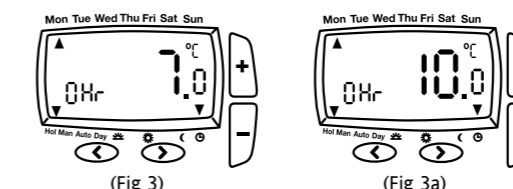

(Fig 3)

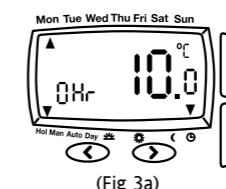

(Fig 3a)

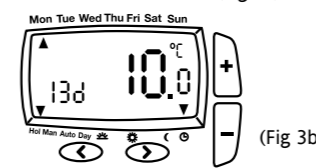

(Fig 3b)

### Battery Model only.

#### How do I know when to change the batteries.

When the batteries start to run low a battery icon will blink for 15 seconds every 15 seconds to indicate "low battery" during this time the *Digistat+2* will function normally (see fig 4). Please replace batteries with (2 x AA 1.5V Alkaline batteries). After 6 months the *Digistat+2* will cease to function and will permanently display the battery icon and nothing else, shown in (fig 5).

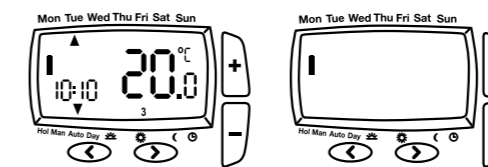

(Fig 4)

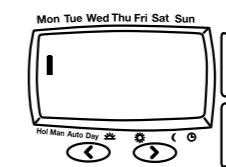

(Fig 5)

**How to replace the batteries see fig 6.**  
Remove the battery cover using a coin. Replace the spent batteries with 2 x AA 1.5V alkaline batteries ensuring correct orientation. Replace the battery cover pressing fully home.

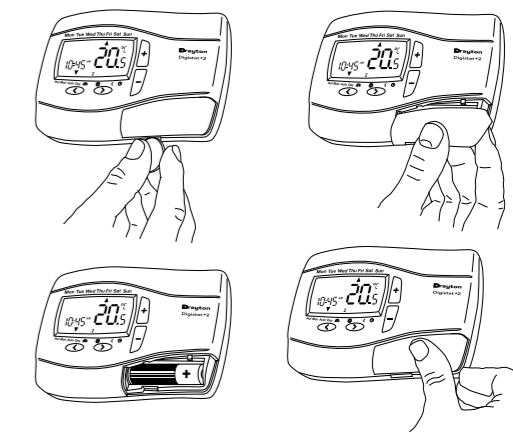

(Fig 6)

### How to change the time, day, month & year.

*Digistat+2* comes with a pre-set clock, which also automatically adjusts for summer/winter time changes. It is activated automatically on 1st installation. There should be no need to change these settings, however, should you wish to, it can be done in clock mode.

To enter the clock mode press > to move through Day and all 6 time/temperature events until the arrow points to the clock symbol. The time will now flash and can be adjusted (Fig 7) by pressing + or - then press > to accept and move to Day.

### Change day.

If you wish to change the day press + or - then press > to accept. *Digistat+2* will move to the next field - month.

### Change month.

If you wish to change the month press + or - then press > to accept. *Digistat+2* will move to the next field - Year.

### Change year.

If you wish to change the year press + or -, then press > to accept. *Digistat+2* will now return to Auto mode.

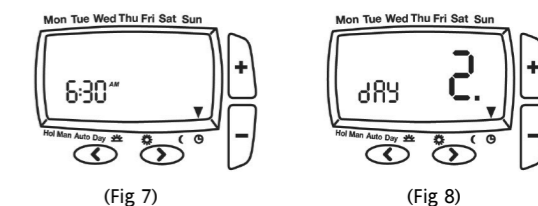

(Fig 7)

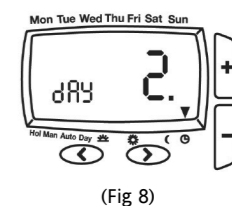

(Fig 8)

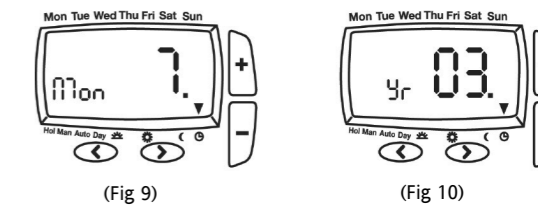

(Fig 9)

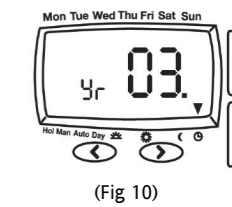

(Fig 10)

### Display Error code E1 or E2.

When the display shows E1 or E2 this indicates a sensor fault and your heating system will remain Off. Please contact your installer.

### How to select another pre-set time/temperature program.

There are 3 pre-set time/temperature programs already held in memory as shown, if pre-set program 1 is the best program to suit your lifestyle do nothing and the *Digistat+2* will control to program 1. If you would like to select one of the other pre-set programs, refer to 'How to change User Options', Option 3 and select your preferred program.

Pre-set programs for Digistat+2 24 Hour.

Program 1 (9 till 5) as shown below

	Monday	Tuesday	Wednesday	Thursday	Friday	Saturday	Sunday
Events	1	2	3	4	5	6	
Time	6:30	8:30	12:00	14:00	16:30	22:30	
Temperature C	20.0	16.0	16.0	16.0	21.0	7.0	

Program 2 (Home for lunch)

	Monday	Tuesday	Wednesday	Thursday	Friday	Saturday	Sunday
Events	1	2	3	4	5	6	
Time	6:30	8:30	12:00	14:00	16:30	22:30	
Temperature C	21.0	16.0	21.0	16.0	21.0	10.0	

Program 3 (Home worker)

	Monday	Tuesday	Wednesday	Thursday	Friday	Saturday	Sunday
Events	1	2	3	4	5	6	
Time	6:00	8:30	12:00	14:00	17:30	22:30	
Temperature C	21.0	19.0	21.0	19.0	21.0	16.0	

How to change the pre-set time/temperature program to my own selection.

Press > to select the day function. (refer to fig 11). This indicates that any changes made are valid for all days of the week.

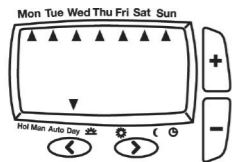

(Fig 11)

Press > to view the existing time/temperature event (1). (Fig 12) time will flash. Press > again to view the temperature setting, temperature will flash. Press > again to view the 2nd time/temperature event (Fig 12a).

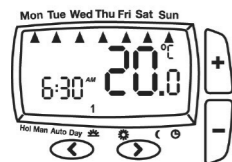

(Fig 12)

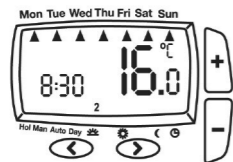

(Fig 12a)

When you get to the event you wish to change press + or - to change the required time, then Press > to accept. Use + or - to select the required temperature, then > to accept. Digistat+2 will now show the next time/temperature event. To exit press < until you return to Auto mode.

How to change User Options.

If you wish to change any user options 1 to 8 shown in table 1 they can be accessed from Auto or Man by pressing < and > simultaneously for 3 seconds. Once you have accessed the user setting Menu (Fig 13) press > to scroll through selectable options 1 to 8. The settings for each option can be changed by pressing + or - as required. Press > to accept the change and move to the next option. To exit press < and > simultaneously for 3 seconds. Alternatively, not pressing any buttons for 2 mins will cause the Digistat+2 to return to Auto. (Fig 13a) shows option 1 24 (24 hour clock). Only selected options which have been accepted by pressing > will be changed.

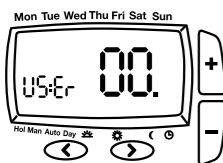

(Fig 13)

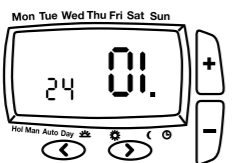

(Fig 13a)

What is a programmable room thermostat?

...an explanation for householders

A programmable room thermostat is both a programmer and a room thermostat. A programmer allows you to set 'On' and 'Off' time periods to suit your own lifestyle. A room thermostat works by sensing the air temperature, switching on the heating when the air temperature falls below the thermostat setting, and switching it off once this set temperature has been reached.

So, a programmable room thermostat lets you choose what times you want the heating to be on, and what temperature it should reach while it is on. It will allow you to select different temperatures in your home at different times of the day (and days of the week) to meet your particular needs.

Turning a programmable room thermostat to a higher setting will not make the room heat up any faster. How quickly the room heats up depends on the design of the heating system, for example, the size of boiler and radiators.

Neither does the setting affect how quickly the room cools down. Turning a programmable room thermostat to a lower setting will result in the room being controlled at a lower temperature, and saves energy.

The way to set and use your programmable room thermostat is to find the lowest temperature settings that you are comfortable with at the different times you have chosen, and then leave it alone to do its job. The best way to do this is to set low temperatures first, say 18C, and then

turn them up by one degree each day until you are comfortable with the temperatures. You won't have to adjust the thermostat further. Any adjustments above these settings will waste energy and cost you more money.

If your heating system is a boiler with radiators, there will usually be only one programmable room thermostat to control the whole house. But you can have different temperatures in individual rooms by installing thermostatic radiator valves (TRVs) on individual radiators. If you don't have TRVs, you should choose a temperature that is reasonable for the whole house. If you do have TRVs, you can choose a slightly higher setting to make sure that even the coldest room is comfortable, then prevent any overheating in other rooms by adjusting the TRVs.

The time on the programmer must be correct. Some types have to be adjusted in spring and autumn at the changes between Greenwich Mean Time and British Summer Time.

You may be able to temporarily adjust the heating programme, for example, 'Override', 'Advance' or 'Boost'. These are explained in the manufacturer's instructions.

Programmable room thermostats need a free flow of air to sense the temperature, so they must not be covered by curtains or blocked by furniture. Nearby electric fires, televisions, wall or table lamps may prevent the thermostat from working properly.



User options	What is it	Min	Max	Default
1	Change 12h or 24h clock	12	24	24
2	Change the manual set point temperature °C	7 °C	32 °C	20 °C
3	Change to another pre-set programme	1	3	1
4	Change the number of programme events per day	2, 4 or 6		6
5	Switch on/off automatic summer/winter time change	On	Off	On
6	Change temperature offset °C	-5	5	0
7	Restore pre-set programme	On	Off	Off
8	To enable Off function	On	Off	Off

(Table 1)

How to change from 24hr to 12hr clock (Option 1).

Enter user options, select option 1 and use + and - keys to select desired option, 12 = 12hr and 24 = 24hr. Press > to accept change.

How to change the default manual set-point temperature (Option 2).

Enter user options, select option 2 and use + and - keys to set desired temperature. Press > to accept desired change.

How to change to another predefined program 1, 2 or 3 (Option 3).

Enter user options, select option 3 and use + and - keys to select desired program 1, 2 or 3. 1 = program 1, 2 = program 2 and 3 = program 3. Press > to accept desired change.

How to change the number of program events per day (Option 4).

Enter user options, select option 4 and use + and - keys to select desired option. 2 = 2 time / temp events per day, 4 = 4 time / temp events per day and 6 = 6 time / temp events per day. Press > to accept desired change.

How to switch on/off the automatic summer / winter time change (Option 5).

Twice a year the actual time is automatically changed to keep it in line with the summer / winter time change. Default setting is On. If you wish to disable / enable this feature enter user options, select option 5 and press - or + key to display Off or On as desired. Press > to accept desired change.

Drayton

401 Southway Drive  
Plymouth  
PL6 6QT  
United Kingdom

Drayton Controls reserve the right to make changes without notice and cannot accept liability for errors.

Installer Options.

If you wish to change any of the Installer Options as shown below, enter the Installer Option Menu from Auto mode by pressing < and + simultaneously for 5 seconds. Pressing < and + again for 5 seconds will exit the Menu and return to Auto mode. Once the Installer Options screen has been selected (Fig 8), the < and > buttons allow you to scroll through the Menu (shown below). The + and - allow you to change values. Once a value has been changed pressing > before exiting the Menu will save the new setting. (Fig 9 shows Option 1 OFF).

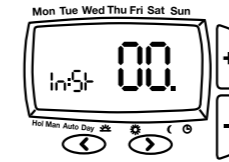

(Fig 8)

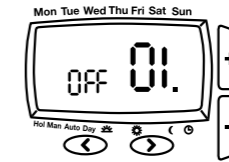

(Fig 9)

Installer Options	What is it	Select between	Default
1	Access protection lock	On Off	Off
2	Freeze protection	On Off	On
3	Low limit set point °C	7 High limit	7
4	High limit set point °C	Low limit 32	32
5	Delayed start (Energy saving feature)	On Off	Off
6	Valve protection	On Off	Off
7	Valve protection time (Mins)	1 5	3
8	Sensor fault function	On Off	Off
9	Application type	0 3	0
10	System capability	0 1	0

Access protection lock.

The access protection lock allows the installer to lock the Digistat+2 so that the user cannot make any adjustments. The default is OFF mode allowing the users to adjust the Digistat+2 (see User Guide).

To Lock the Digistat+2 settings enter the Installer Options Menu (Refer to Installer Option 1) and select On and press > to accept. Once the Installer Options Menu is exited all buttons will be locked.

To switch off the Protection Lock enter the Installer Menu and change to OFF. Press > to accept.

Once the Installer Menu is exited all buttons will be free to adjust.

Freeze protection.

Freeze protection will switch on the heating if the room temperature falls to 5°C and will then control the temperature at 7°C even if the Digistat+2 is in OFF mode. The freeze protection default is ON.

To switch off the Freeze protection mode enter the Installer Options Menu (Refer to Installer Options 2) and change to OFF. Press > to accept.

Low and High Limit set points.

The user temperature set points defaults are High 32°C and Low 7°C, to change these limits enter the Installer Options Menu (Refer to Installer Options 3 & 4).

Intelligent Delayed Start (Energy saving feature).

The Intelligent Delayed Start is an energy saving feature which automatically reduces the warm up time for the heating system. As the weather becomes milder, Intelligent Start will delay the heating start times so that fuel is not wasted bringing the room up to temperature earlier than necessary.

Note: Intelligent Delayed Start only applies in Auto mode.

Intelligent Delayed Start default is in OFF mode.

To switch on Intelligent Delayed Start enter the Installer Options Menu (Refer to Installer Options 5).

Note the Intelligent Delayed start option is not suitable for Hydronic underfloor application. Ensure Installer option 5 is set to Off before final commissioning for Hydronic underfloor application.

Valve protection.

In some hydronic heating systems there may be a requirement to protect the valve by operating it once a day, for a given period without bringing on the heating system.

If valve protection is selected the valve will be operated for a period as shown in Valve protection time (mins).

Valve protection time every day at 10.00am.

Valve protection default is OFF.

To enable the valve protection mode enter the Installer Options Menu (Refer to Installer Option 6)

Valve protection time (mins).

Valve protection time can be set between 1 and 5 minutes (default 3 minutes)

To change this once a day on time enter the Installer Options Menu (Refer to Installer Option 7).

Sensor fault function.

When the display shows an error code (E1) or (E2) this indicates a sensor fault and the heating system will remain Off.

(E1) = internal sensor and (E2) = external sensor.

If (E1) is shown the Digistat+2 should be replaced.

If (E2) is shown, first check the external sensor terminal block connections before replacing the Digistat+2.

Sensor fault function allows you to temporarily set the Digistat+2 to cycle the heating system 30% On and 70% Off until you have replaced the product.

This can be done by entering the installer Option Menu (Option 8) and selecting On. Press > to accept.

To reset to default Off, entering the installer Option Menu (Option 8) and selecting Off. Press > to accept.

Application Type.

Digistat+2 can be used for different applications.

In the installer menu, select:

- 00 = Gas Boiler
- 01 = Oil Boiler
- 02 = Electric Heat
- 03 = Hydronic Underfloor

System Capability

Adjust this setting to suit the heating system capability.

In the installer menu, select:

- 00 = Fast – the house usually reaches setpoint in < 1 hour
- 01 = Slow – the house usually reaches setpoint in > 1 hour

Drayton – Digistat+2 24 Hour Programmable Room Thermostat

Programs are the same every day (Monday to Sunday).

Technical Data

Model	22084	22088
Power supply	2 X AA 1.5V alkaline batteries	230V ac 50Hz
Battery life	3 years typical	-
Switch rating Heating (switch N.O.)	16(2)A 230 Vac	
Switch type	SPDT (voltage free contacts)	
Min. recommended current	10mA @24Vac (inductive)	
Ambient temperature	Operating 0°C to 50°C Storage – 20°C to 85°C	
Ambient humidity (non condensing)	Operating 25% to 85% Storage 15% to 95%	
Temperature range	7°C to 32°C	
Accuracy (between 7°C & 32°C)	0.5°C	
Timing resolution	1 minute	
Temperature resolution	0.5°C	
Rated impulse voltage	2.5kV	
Ball pressure test	75°C	
Pollution situation	Degree 2	
Protection level	IP30	
Wiring:	Designed for fixed wiring only, to comply with IEE wiring regulations	
Energy Class	IV = 2% (According to EU 811/2013, 812/2013, 813/201, 814/2013)	

Relevant EC Directives:	2014/35/EU Low Voltage Directive 20014/30/EU Electromagnetic Compatibility Directive 2011/65/EU RoHS Directive 2006/66/EC Battery Directive Applied
Standards:	EN60730-1; EN60730-2-7; EN60730-2-9

Drayton

401 Southway Drive  
Plymouth  
PL6 6QT  
United Kingdom

Drayton Controls reserve the right to make changes without notice and cannot accept liability for errors.