

Biflo with LWC1 to a Digistat Battery Version

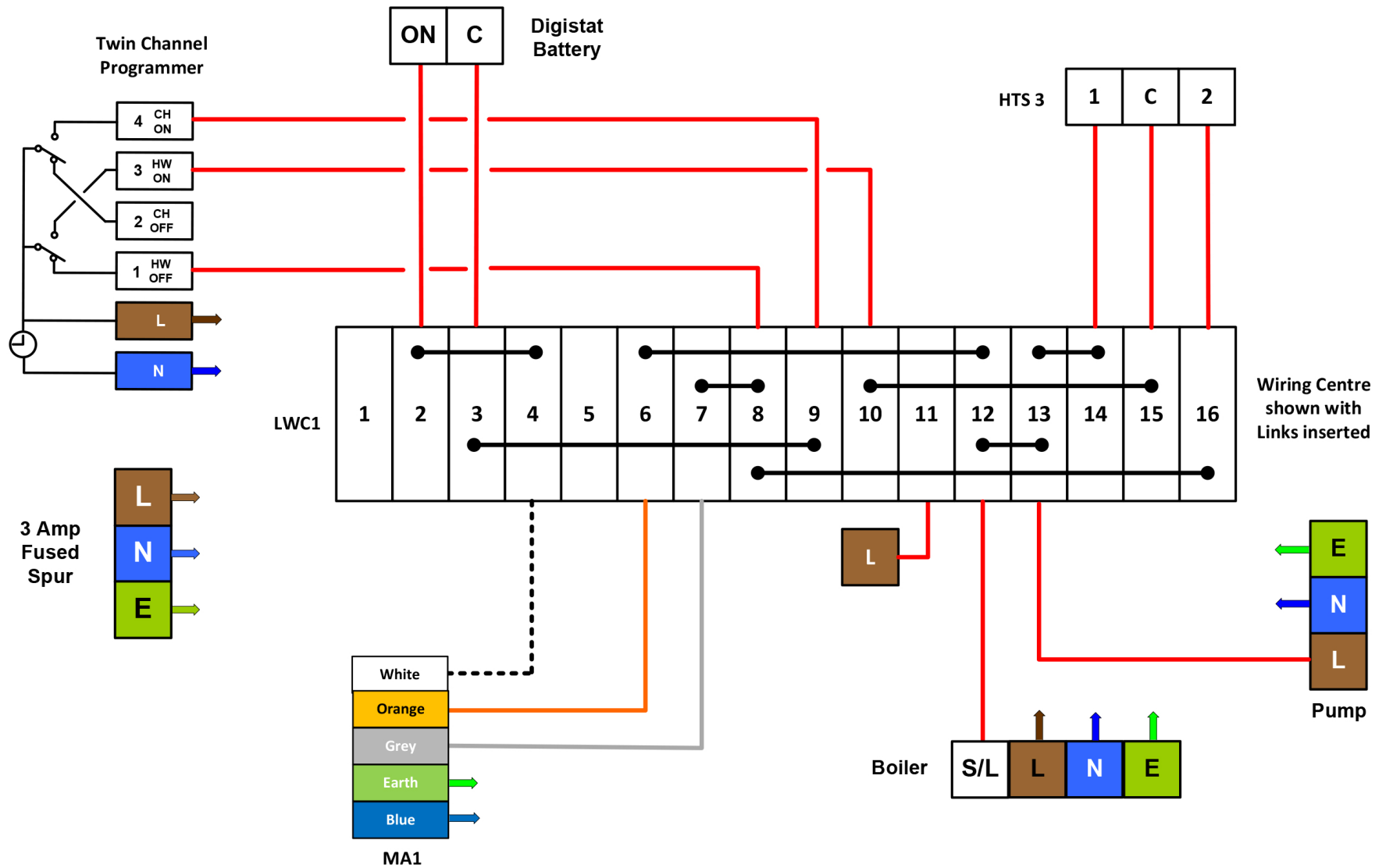

Drayton ED04-1

The above diagram is for guidance only, Drayton accept no liability for any loss or damage arising from any errors or omissions that may be inadvertently contained within this diagram. equipment manufacturers of associated products should be consulted to confirm compatibility with drayton products prior to installation.

PLEASE NOTE: INSTALLATION MUST ONLY BE CARRIED OUT BY A QUALIFIED ELECTRICIAN OR HEATING ENGINEER

Drayton

by Schneider Electric